

Архангельск (8182)63-90-72
Астана (7172)727-132
Астрахань (8512)99-46-04
Барнаул (3852)73-04-60
Белгород (4722)40-23-64
Брянск (4832)59-03-52
Владивосток (423)249-28-31
Волгоград (844)278-03-48
Вологда (8172)26-41-59
Воронеж (473)204-51-73
Екатеринбург (343)384-55-89
Иваново (4932)77-34-06

Ижевск (3412)26-03-58
Иркутск (395)279-98-46
Казань (843)206-01-48
Калининград (4012)72-03-81
Калуга (4842)92-23-67
Кемерово (3842)65-04-62
Киров (8332)68-02-04
Краснодар (861)203-40-90
Красноярск (391)204-63-61
Курск (4712)77-13-04
Липецк (4742)52-20-81
Киргизия (996)312-96-26-47

Магнитогорск (3519)55-03-13
Москва (495)268-04-70
Мурманск (8152)59-64-93
Набережные Челны (8552)20-53-41
Нижний Новгород (831)429-08-12
Новокузнецк (3843)20-46-81
Новосибирск (383)227-86-73
Омск (3812)21-46-40
Орел (4862)44-53-42
Оренбург (3532)37-68-04
Пенза (8412)22-31-16
Казахстан (772)734-952-31

Пермь (342)205-81-47
Ростов-на-Дону (863)308-18-15
Рязань (4912)46-61-64
Самара (846)206-03-16
Санкт-Петербург (812)309-46-40
Саратов (845)249-38-78
Севастополь (8692)22-31-93
Симферополь (3652)67-13-56
Смоленск (4812)29-41-54
Сочи (862)225-72-31
Ставрополь (8652)20-65-13
Таджикистан (992)427-82-92-69

Сургут (3462)77-98-35
Тверь (4822)63-31-35
Томск (3822)98-41-53
Тула (4872)74-02-29
Тюмень (3452)66-21-18
Ульяновск (8422)24-23-59
Уфа (347)229-48-12
Хабаровск (4212)92-98-04
Челябинск (351)202-03-61
Череповец (8202)49-02-64
Ярославль (4852)69-52-93

<https://teeter.nt-rt.ru> || tty@nt-rt.ru

DEX

Assembly & Use Instructions

For gravity-assisted stretching and decompression

TEETER



* Specifications may vary from this image and are subject to change without notice.

BEFORE YOU BEGIN: Review all steps before beginning assembly and read all precautions before using the DEX II. Carefully adhere to the Assembly & Use Instructions to help ensure safety and product integrity.

IMPORTANT SAFETY INSTRUCTIONS **READ ALL INSTRUCTIONS BEFORE USING THE DEX II**

⚠ WARNING

FAILURE TO FOLLOW INSTRUCTIONS AND WARNINGS COULD RESULT IN SERIOUS INJURY OR DEATH.

To reduce the risk of injury:

- Read and understand all the instructions, review all other accompanying documents, and inspect the equipment before using the DEX II™. It is your responsibility to familiarize yourself with the proper use of this equipment and the inherent risks of inversion if these instructions are not followed, such as falling on your head or neck, pinching, entrapment, equipment failure, or aggravating a pre-existing medical condition. It is the responsibility of the owner to ensure that all users of the product are fully informed about the proper use of the equipment and all safety precautions.
- **DO NOT** use until approved by a licensed physician. Inversion is contraindicated in any medical or health condition that may be made more severe by an elevation of blood pressure, intracranial pressure or mechanical stress of the inverted position, or that may impact your ability to operate the equipment. This may include injury or illness, but also the side effects of any drug or supplement (prescribed or over-the-counter). Specific conditions may include, but not be limited to:
 - Any condition, neurological or otherwise, which results in unexplained tingling, weakness or neuropathy, seizure, sleep disorder, lightheadedness, dizziness, disorientation, or fatigue, or impacts strength, mobility, alertness, or cognitive ability;
 - Any brain condition, such as trauma, history of intracranial bleed, history or risk of TIA or stroke, or severe headaches;
 - Any condition of the heart or circulatory system, such as high blood pressure, hypertension, increased risk of stroke, or use of anticoagulants (including high doses of aspirin);
 - Any bone, skeletal or spinal cord condition or injury, such as significant spinal curvature, acutely swollen joints, osteoporosis, fractures, dislocations, medullary pins or surgically implanted orthopedic supports;
 - Any eye, ear, nasal or balance condition, such as trauma, history of retinal detachment, glaucoma, optic hypertension, chronic sinusitis, middle or inner ear disease, motion sickness, or vertigo;
 - Any digestive or internal condition, such as severe acid reflux, hiatal or other hernia, gallbladder or kidney disease;
 - Any condition for which exercise is specifically directed, limited or prohibited by a physician, such as pregnancy, obesity, or recent surgery.
- **ALWAYS** be certain the equipment is properly adjusted before using. HEAR, FEEL, and SEE that the Locking Pin and Leg Support Adjustment Knob are fully engaged and tightened prior to use.
- **DO NOT** use the equipment until it is adjusted properly for your height and leg size. **ALWAYS** ensure that your hips are aligned with the top edge of the Lap Pad and that your thighs fit snugly, yet comfortably between the rollers and the Lap Pad, with no room between the back of your thighs and the leg rollers.
- New users will require the assistance of a spotter possessing the physical strength to lift and return the user to the upright position.
- **ALWAYS** ensure that your knees are slightly bent during inversion to avoid hyperextension and possible injury. **ALWAYS** ensure you have your balance before completing your dismount.
- **DO NOT** continue using the equipment if you feel pain or become light-headed or dizzy while inverting. Immediately return to the upright position for recovery and eventual dismount.
- **DO NOT** use if you are over 6 ft 6 in (198 cm) or over 300 lbs. (136 kg). Structural failure could occur or head/neck may impact the floor during inversion.
- **DO NOT** allow children to use this machine. Keep children, bystanders, and pets away from machine while in use. The equipment is not intended for use by persons with reduced physical, sensory or mental capabilities.
- **DO NOT** store outdoors.
- **DO NOT** use aggressive movements, or use weights, elastic bands, any other exercise or stretching device or non-Teeter® attachments while inverted on the equipment. Use the equipment only for its intended use as described in this manual.
- **DO NOT** drop or insert any object into any opening. Keep body parts, hair, loose clothing and jewelry clear of all moving parts in order to avoid pinching hazard.
- **DO NOT** use in any commercial, rental or institutional setting. This product is intended for indoor, home-use only.
- **DO NOT** operate equipment while under the influence of drugs, alcohol, or medication that may cause drowsiness or disorientation.
- **ALWAYS** inspect the equipment prior to use. Make sure all fasteners are secure and the Lap Pad rotates smoothly.
- **ALWAYS** replace defective components immediately and/or keep the equipment out of use until repair.
- **ALWAYS** position equipment on a level surface and away from water or ledges that could lead to accidental immersion or falls.
- Refer to additional warning notices posted on the equipment. If a product label or Owner's Manual should become lost, damaged or illegible, contact Customer Service for replacement.

SAVE THESE INSTRUCTIONS

Items for Assembly

Items not shown to scale. Hardware drawings located on the insert inside each Hardware Kit.

ITEM NO.	ITEM NAME
Base Assembly	
H12009	Base Frame
H12018	Derattler Knob
D11012	Two (2) Base Feet
H12010	Two (2) Legs
D11013	Two (2) Leg Feet
Lap Pad Assembly	
H12006	Lap Pad Frame
D11005	Lap Pad

ITEM NO.	ITEM NAME
Leg Support Assembly	
H12016	Leg Support Adjustment Knob
H12019	Leg Support Shaft
Tools Provided for Assembly	
H12014	Two (2) Wrenches (13/14mm)
H12015	Screwdriver

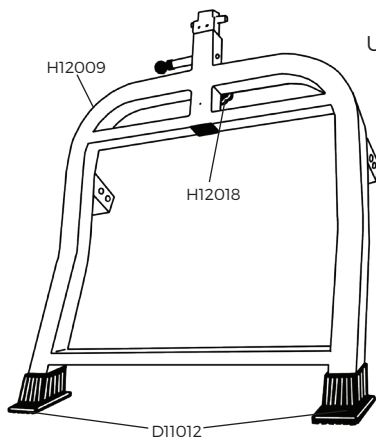

Base Assembly
Use with Base Assembly Hardware Kit (D11019)

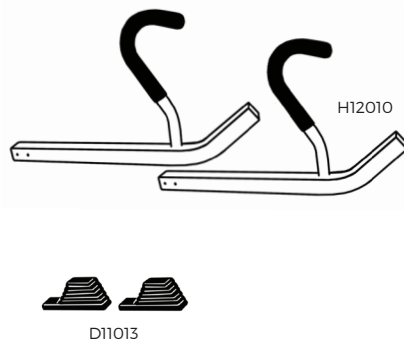

Leg Support Assembly
Use with Leg Support Assembly Hardware Kit (D11021)

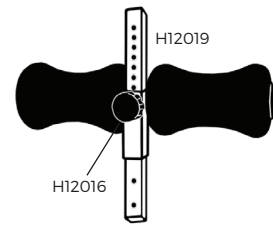

Lap Pad Assembly
Use with Lap Pad Assembly Hardware Kit (D11020)

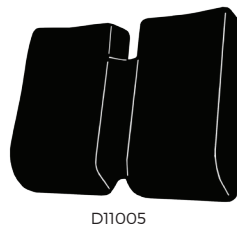
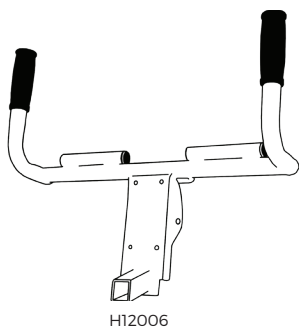

Tools Provided for Assembly

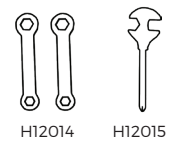

Understanding Your DEX II™

Before reading further, study the drawing below to familiarize yourself with the important components of your Teeter DEX II™



Identifying Parts and Components

1	Leg Rollers	7	Height Adjustment Handle
2	Leg Support Adjustment Knob	8	Height Adjustment Locking Pin
3	Lap Pad	9	Derattler Knob
4	Chrome Shaft	10	Cane Shaped Handles
5	Base Feet	11	Leg Feet
6	Traction Handles		

Safety Warning Labels & Product Specifications

Important: Please review all labels and supporting materials before using your DEX II™.

This drawing indicates the locations of the warning labels found on your product. If a label is missing, illegible or is removed, contact Teeter Customer Service to request a complimentary replacement label.

Note: Image and labels below not shown at actual size.



Assembled Non-Use Dimensions: 41.0 (L) x 29.0 (W) x 48.0 in (H) (104.1 x 73.7 x 114.3 cm)

Maximum In-Use Dimensions: 41.0 (L) x 29.0 (W) x 48.0 in (H) (104.1 x 73.7 x 114.3 cm)

Weight (approx.): 66.1 lbs (30.1 kg)

Before Beginning Assembly

Unpack and Prepare Your Workspace

- If possible, set up the product at or near the space in which you intend to use it to avoid moving it later.
- Unpack all parts and support materials. Follow the unpacking instructions included in the box. Set aside packing materials and clear your work area.
- Locate the Hardware Kits, packaged with the manuals. They are labeled to correspond with the assembly process.

STEP ①

Assemble Base & Leg Feet

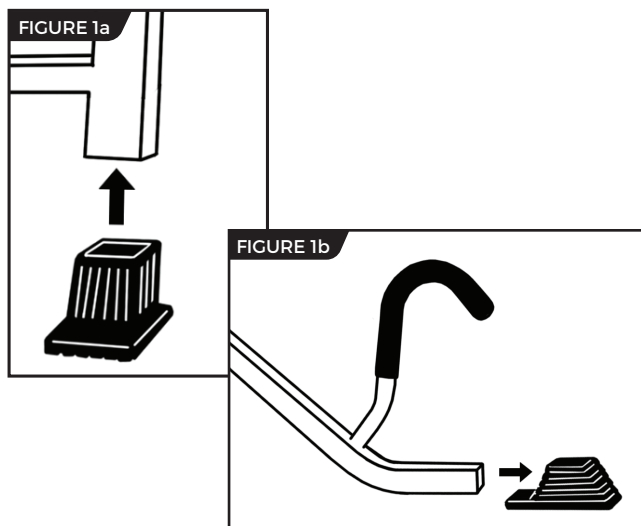

- Slide the Base Feet onto the end of the Base Frame (Figure 1a).
- Slide the Leg Feet onto the end of the Legs (Figure 1b).
- Push firmly on all four feet to ensure they are fully mounted.

STEP ②

Attach Legs to Base

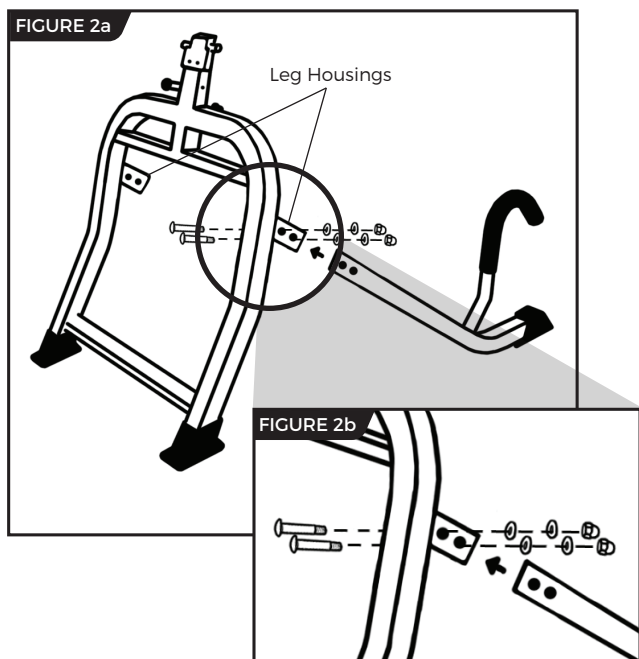

- Locate the Base Assembly Hardware Kit (D11019).
- With the Cane Shaped Handle facing upward, insert one Leg into the Leg Housing of the Base Frame until the two bolt holes align (Figure 2a).
- Insert two Threaded Bolts from the inside of the Leg Housing through the holes. Secure on the outside of the Leg Housing using the Flat Washer, Lock Washer and Bolt Cap, in that order. Tighten with the Wrenches provided (Figure 2b).
- Repeat with the other Leg.

STEP ③

Assemble Lap Pad to Lap Pad Frame

- Locate the Lap Pad Assembly Hardware Kit (D11020). In this step, you will only use the four (4) small screws.
- With the Lap Pad face down, rest the Lap Pad Frame on top of the Lap Pad. Make sure the Traction Handles are pointing up and the Leg Support Shaft Housing rests inside the indented area of the Lap Pad. Align the screw holes (Figure 3).
- Insert the screws through the holes and tighten with the Screwdriver.

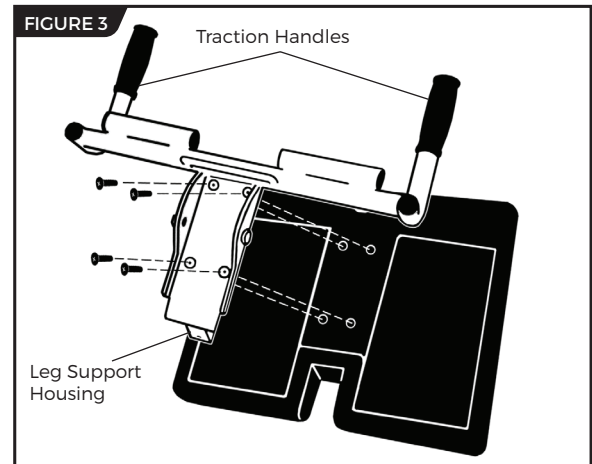

STEP ④

Secure Lap Pad Assembly to Base Assembly

- You will use the remainder of the Lap Pad Hardware Kit (D11020) from Step 3.
- Thread the Hex Bolt through a Flat Washer and Spacer. Make sure the small end of the Spacer faces away from the head end of the Hex Bolt.
- With the Traction Handles facing the rear of the Base Assembly, place the Lap Pad Assembly over the Chrome Shaft of the Base Frame and align the holes (Figure 4a & 4b).
- Insert the Hex Bolt with Flat Washer and Spacer through the holes to secure the Lap Pad Assembly to the Chrome Shaft.
- Thread the remaining Spacer (with the small end facing the Chrome Shaft) and Flat Washer onto the end of the Hex Bolt. Fasten the Hex Nut using the wrenches provided (Figure 4b).
- Make sure the fasteners are securely tightened and the Lap Pad rotates smoothly.

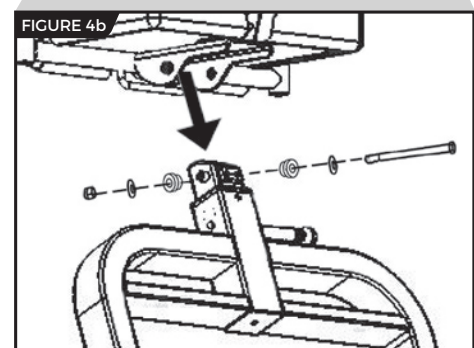
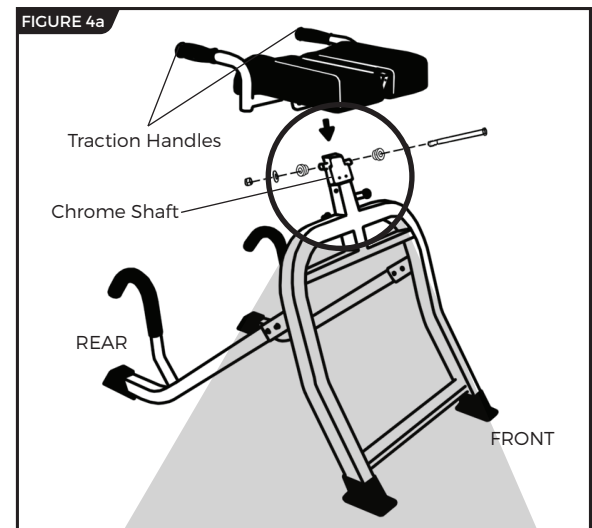

STEP ⑤

Attach Leg Support Assembly to Lap Pad Assembly

- Locate the Leg Support Assembly Hardware Kit (D11021).
- Thread the washers onto the bolts.
- With the Leg Support Adjustment Knob facing down, slide the Leg Support Shaft into the receiving end of the Lap Pad Assembly (Figure 5).
- Lining up the two holes, insert the Hex Bolts with washers. Secure with one of the wrenches provided.
- Test the Lap Pad for smooth and steady rotation and that all fasteners are secure:
 - » Stand between the Cane Shaped Handles with your body facing the machine.
 - » Grasp the Traction Handles and rotate the Lap Pad towards you.
 - » Apply your full weight to the Traction Handles by lifting your legs off the floor and lightly bouncing (Figure 6).

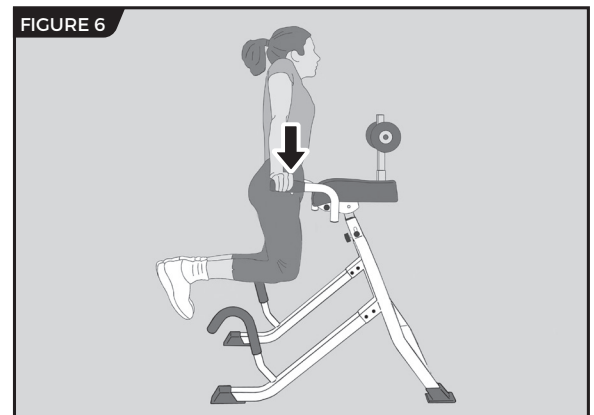
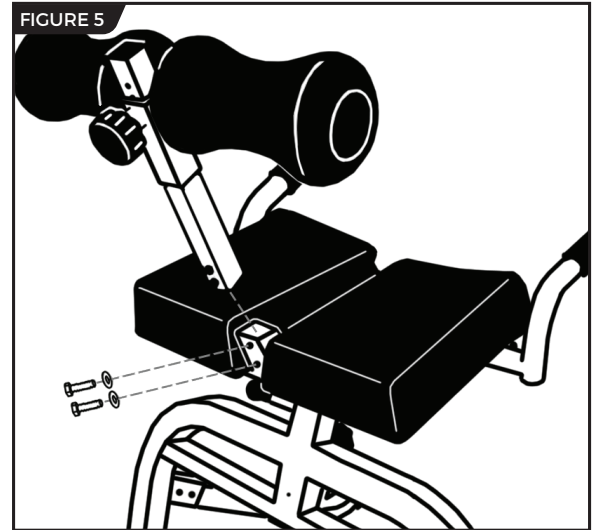

⚠ WARNING

ALWAYS ensure that all parts are assembled correctly and read the User Settings/How to Invert thoroughly before using your Teeter DEX II™. Improper assembly or settings could result in serious injury or death!

User Settings

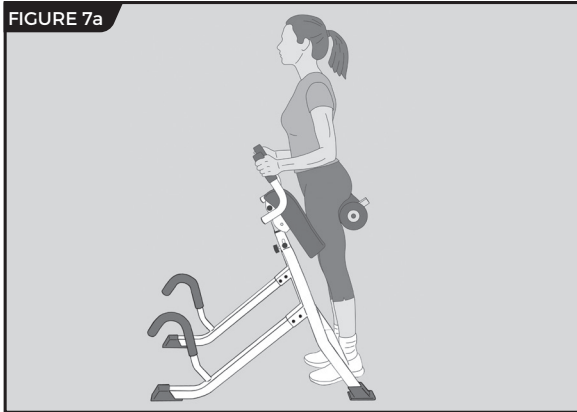

Adjust the Height of the Lap Pad:

The Lap Pad needs to be adjusted so that while standing on the Base Frame platform, your hips are aligned with the top edge of the Lap Pad (Figures 7a and 7b).

1. Loosen the Derattler Knob by rotating it several turns counterclockwise (Figure 8).
2. While holding the Height Adjustment Handle on the Lap Pad, pull the Height Adjustment Locking Pin and lift or lower the Lap Pad to your ideal height (Figure 9).
3. Release the Locking Pin so that it engages fully into one of the height settings. Tighten the Derattler Knob by rotating clockwise.

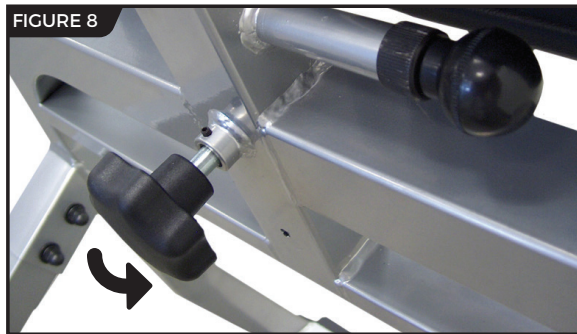
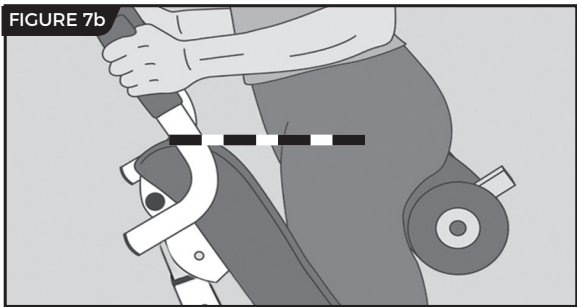

User Settings

Adjust the Depth of the Leg Rollers:

The depth of the Leg Rollers needs to be adjusted so that while standing on the Base Frame platform, your thighs fit comfortably, yet snugly between the rollers and the Lap Pad. Ensure there is no room between the back of your thighs and the Leg Rollers (Figures 10a and 10b).

1. Loosen the Leg Support Adjustment Knob by rotating it several turns counterclockwise, then pull down to disengage the Knob from the hole setting (Figure 11).
2. Slide the Leg Rollers in or out depending on the size of your legs (Figure 12).
3. Release the Leg Support Adjustment Knob so that it engages fully into one of the hole settings. Tighten the Leg Support Adjustment Knob by rotating clockwise.

FIGURE 10a

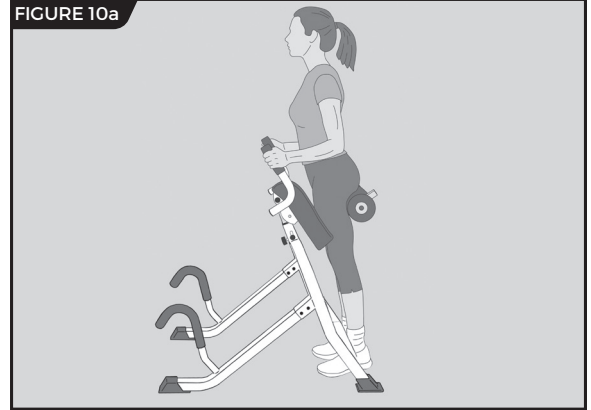
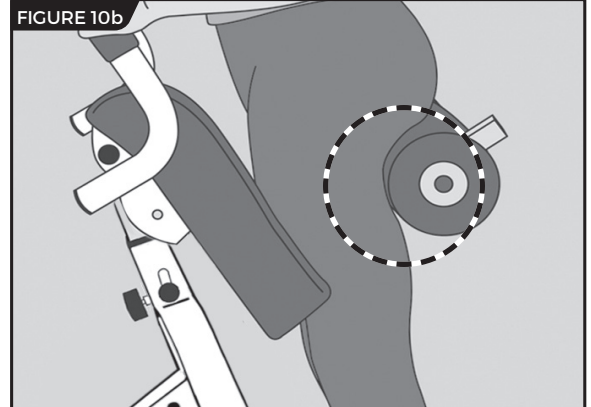

FIGURE 10b



⚠ WARNING

DO NOT use the equipment until it is adjusted properly for your height and leg size. **ALWAYS** ensure that your hips are aligned with the top edge of the Lap Pad and that your thighs fit snugly, yet comfortably between the rollers and the Lap Pad, with no room between the back of your thighs and the leg rollers. Improper settings could result in serious injury or death!

FIGURE 11

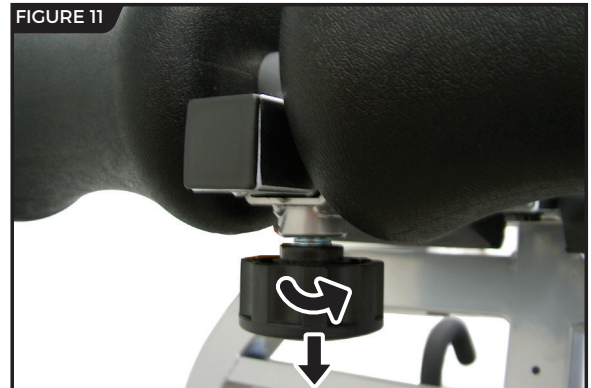

FIGURE 12



How to Invert

FIGURE 13

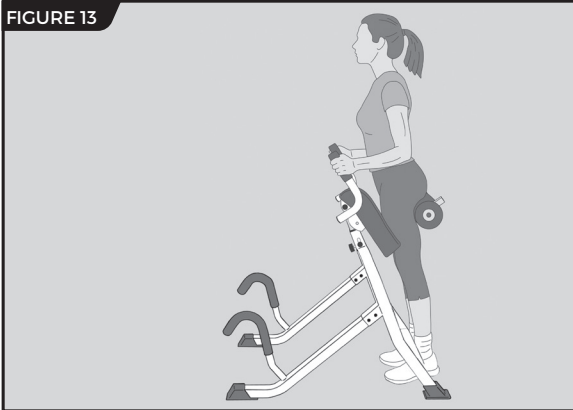

FIGURE 14

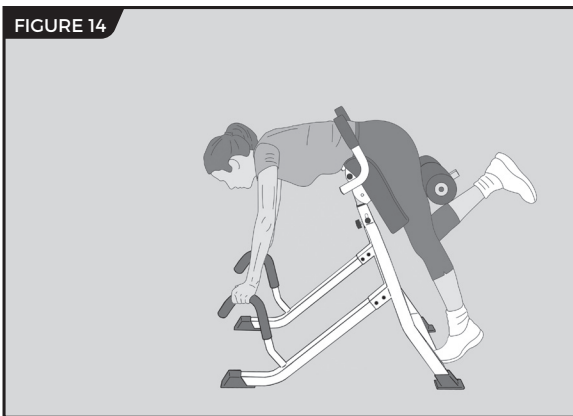

FIGURE 15

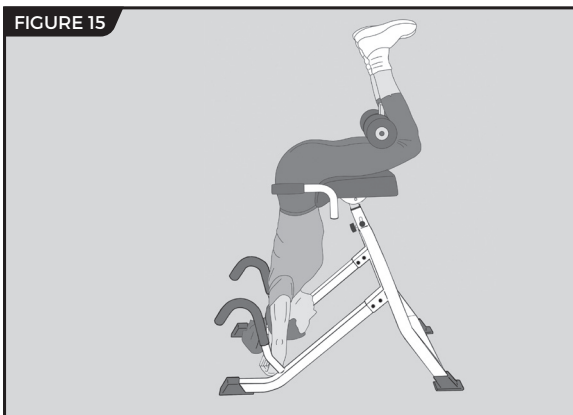
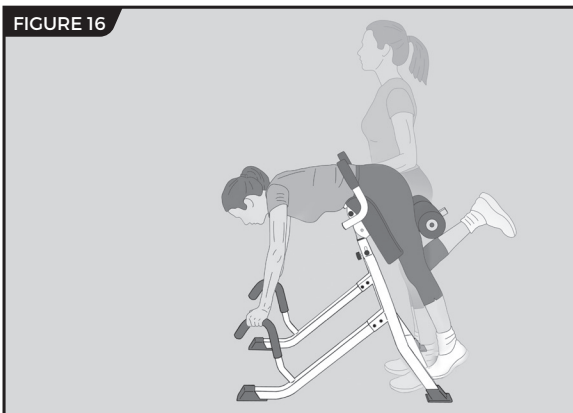

FIGURE 16



Prior to Inverting

- Employ the method of “**HEAR, FEEL, & SEE**” every time prior to inverting:

HEAR the Height Adjustment Locking Pin and Leg Support Adjustment Knob click into place;

FEEL to make sure they are fully engaged and locked in a hole setting, and **FEEL** that they are fully tightened.

SEE that the top of the Lap Pad is aligned with the top of your hips and **SEE** that there is **NO** space between the back of your thighs and the Leg Rollers.

- Step onto the platform of the Base Frame with thighs between the Leg Rollers and Lap Pad (Figure 13).

! WARNING

ALWAYS ensure the Height Adjustment Locking Pin and Leg Support Adjustment Knob are fully engaged prior to use.

Rotating into Inversion

- To begin inversion, bend one knee and slowly lean forward to grab hold of the Cane Shaped Handles (Figure 14).

- While holding the Cane Shaped Handles and supporting your weight, continue to slowly lean forward and rotate the Lap Pad while lifting and bending the other leg (Figure 14).

- Continue rotation until the Lap Pad reaches the stop position. Your body weight will now be supported by your thighs (Figure 15).

- Keep both knees bent around the Leg Rollers. Allow your hands to dangle on the floor or place them folded behind your head (Figure 15).

! WARNING

ALWAYS ensure the your knees are slightly bent during inversion. Failure to do so could result in hyperextension and possible injury!

Dismounting

To return to an upright position:

- Push on the Cane Shaped Handles to gradually walk yourself upright, rotating the Lap Pad and straightening your legs until standing at the start position (Figure 16).

- Carefully disengage your thighs from between the Leg Rollers and Lap Pad. Ensure you have your balance before completing your dismount.

Stretching & Exercise

The following are a few stretches and exercises you can perform on the DEX II™. The following is only a guide - do not advance past your comfort level. If an exercise causes pain, immediately discontinue and eliminate it from your routine.

Traction Stretch

- While inverted, push against the Traction Handles located on the sides of the Lap Pad (Figure 17) to attain a deeper decompressive stretch. Release and repeat.

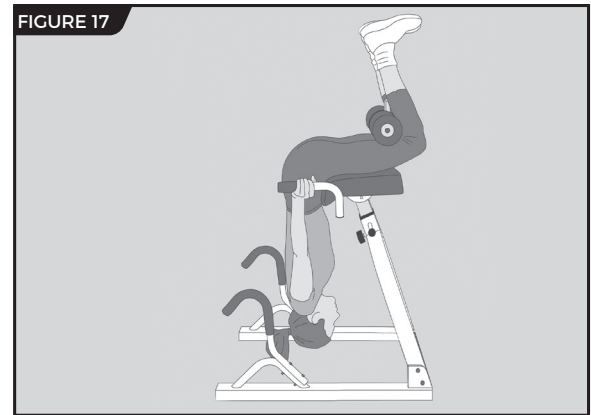

Back Extensions

- Hang fully inverted with hands crossed on your chest or folded behind your head.
- Tighten your glutes and back, and lift your torso up slowly into extension. Make sure to keep abdominal muscles engaged to support the spine while extended (Figure 18a).
- **IMPORTANT:** DO NOT use body momentum for the extension or extend past parallel with the floor.
- Slowly return to the inverted position and repeat.

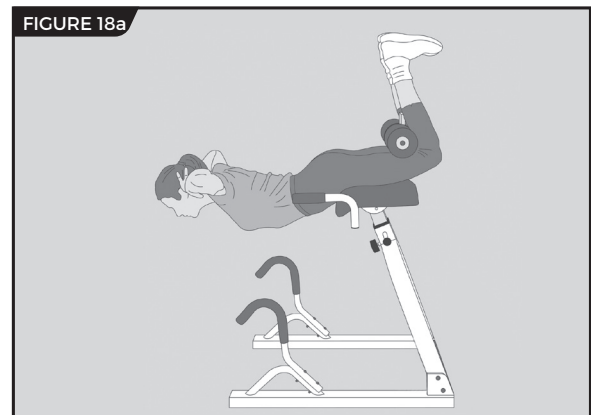

Alternative: Back Extensions - Rotation

- Slightly rotate your torso when extending to work the back extensors and external oblique abdominal muscles (Figure 18b).

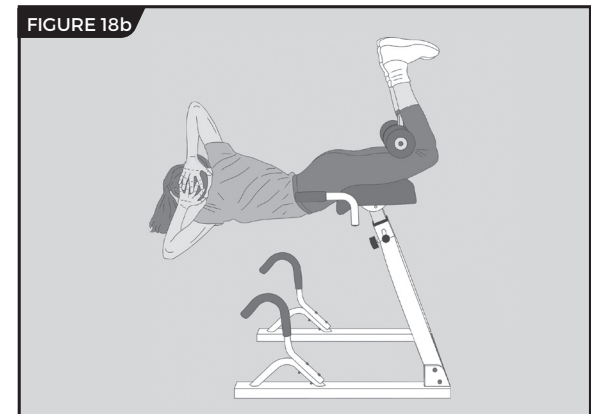

Abdominal Crunches

- Hang fully inverted with hands crossed on your chest or folded behind your head.
- Contract your abdominal muscles, crunching inward toward the base frame (Figure 19). Release and repeat.

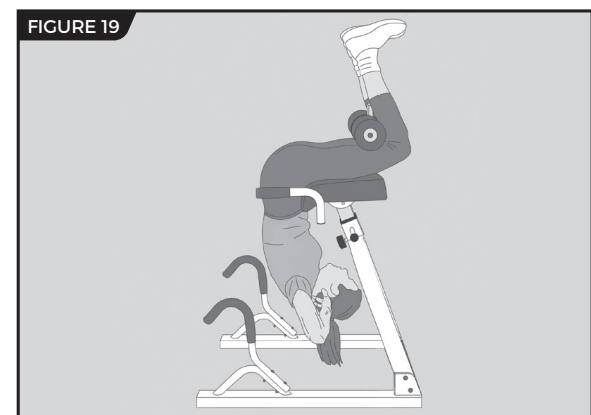

The Teeter warranty set forth below and on Teeter's website applies to US and Canadian customers only. For international customers, please consult your local distributor for warranty information which will vary depending on country.



During the period starting with the day of retail purchase and continuing for five (5) years, Teeter extends to the owner a repair and replacement warranty against manufacturing defects in materials, workmanship, fabrics and padding. Teeter will repair or replace any such defect and will pay the costs of all parts, labor and transportation. If a repair or replacement is not commercially practical or cannot timely be made, then Teeter will, at the original Purchaser's option, replace with a comparable product or refund the purchase price.

Handling and transportation costs related to product warranty service only are covered by this warranty. This warranty does not cover damage resulting from improper handling, assembly, or installation, repairs made by others, accident, misuse, or abuse. Under no circumstances shall Teeter, or any other party involved in the sale of this product, have any liability for incidental or consequential damage arising from breach of an express or implied warranty on any Teeter product.

EXCEPT AS SET FORTH ABOVE, NO WARRANTY IS GIVEN WITH RESPECT TO ANY TEETER PRODUCT, AND ALL EXPRESS WARRANTIES ARE DISCLAIMED. This warranty shall be governed by the laws of the State of Washington, USA. To the extent this warranty is found not to be enforceable, it shall be deemed revised to the extent necessary to make it enforceable. This warranty and any controversy or claim arising out of this warranty or its interpretation shall be governed by the laws of the State of Washington, USA. Any controversy or claim arising out of or relating to this warranty, its interpretation, or any alleged breach thereof, which cannot be amicably settled between Teeter and the owner within sixty (60) days of written notice by the aggrieved party to the other, shall be finally settled by arbitration submitted to three (3) arbitrators selected from the panels of the arbitrators of the American Arbitration Association located closest to Teeter's principal place of business.

Some states do not allow the exclusion of incidental or consequential damage from a warranty, so the above limitation or exclusion may not apply to you. Some states do not allow limitations on how long an implied warranty lasts, so the above limitation may not apply to you. This warranty gives you specific legal rights, and you may also have other rights which may vary from state to state. This warranty is completely transferable to any and all future owners of this product, provided no alterations have been made to the product.

Архангельск (8182)63-90-72
Астана (7172)727-132
Астрахань (8512)99-46-04
Барнаул (3852)73-04-60
Белгород (4722)40-23-64
Брянск (4832)59-03-52
Владивосток (423)249-28-31
Волгоград (844)278-03-48
Вологда (8172)26-41-59
Воронеж (473)204-51-73
Екатеринбург (343)384-55-89
Иваново (4932)77-34-06

Ижевск (3412)26-03-58
Иркутск (395)279-98-46
Казань (843)206-01-48
Калининград (4012)72-03-81
Калуга (4842)92-23-67
Кемерово (3842)65-04-62
Киров (8332)68-02-04
Краснодар (861)203-40-90
Красноярск (391)204-63-61
Курск (4712)77-13-04
Липецк (4742)52-20-81
Киргизия (996)312-96-26-47

Магнитогорск (3519)55-03-13
Москва (495)268-04-70
Мурманск (8152)59-64-93
Набережные Челны (8552)20-53-41
Нижний Новгород (831)429-08-12
Новокузнецк (3843)20-46-81
Новосибирск (383)227-86-73
Омск (3812)21-46-40
Орел (4862)44-53-42
Оренбург (3532)37-68-04
Пенза (8412)22-31-16
Казахстан (772)734-952-31

Пермь (342)205-81-47
Ростов-на-Дону (863)308-18-15
Рязань (4912)46-61-64
Самара (846)206-03-16
Санкт-Петербург (812)309-46-40
Саратов (845)249-38-78
Севастополь (8692)22-31-93
Симферополь (3652)67-13-56
Смоленск (4812)29-41-54
Сочи (862)225-72-31
Ставрополь (8652)20-65-13
Таджикистан (992)427-82-92-69

Сургут (3462)77-98-35
Тверь (4822)63-31-35
Томск (3822)98-41-53
Тула (4872)74-02-29
Тюмень (3452)66-21-18
Ульяновск (8422)24-23-59
Уфа (347)229-48-12
Хабаровск (4212)92-98-04
Челябинск (351)202-03-61
Череповец (8202)49-02-64
Ярославль (4852)69-52-93